

LIFT READY™



# LIFT READY ROLLING GRILLING



Redesigned every possible way to streamline the installation, saving time and money.

LIFT READY PRISTINE  
POLYCARBONATE PANELS

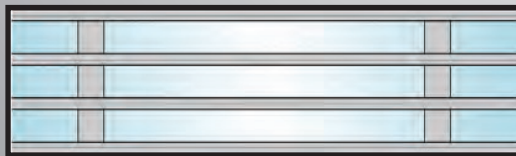

LIFT READY VENTANA  
PERFORATED ALUMINUM

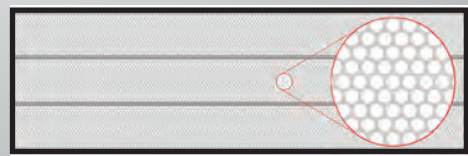

LIFT READY PORTCULLIS  
STRAIGHT GRILLE PATTERN



LIFT READY LABYRINTH  
BRICK GRILLE PATTERN



LIFT READY VORTEX  
SOLID ALUMINUM



PHONE: 1-800-663-4599 FAX: 1-800-205-6665 [www.DynamicClosures.com](http://www.DynamicClosures.com)

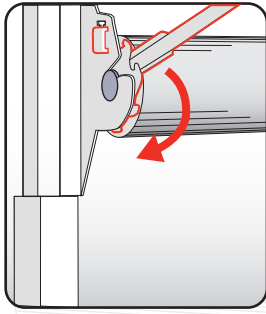

Lift Ready's attached charging arm makes winding the spring easy and safe.

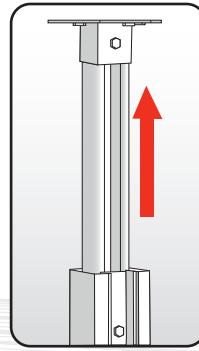

Lift Ready's exclusive extruded aluminum telescoping support tubes make loading, unloading and installing a lighter and easier task. (Optional)

Lift Ready 15" front loading bracket plates allow for quick drop-in barrel installation and level adjustment.

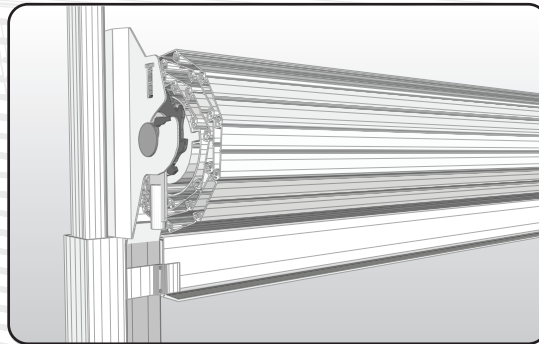

Lift Ready curtains are pre-wrapped on an extruded aluminum barrel simplifying the job on site.

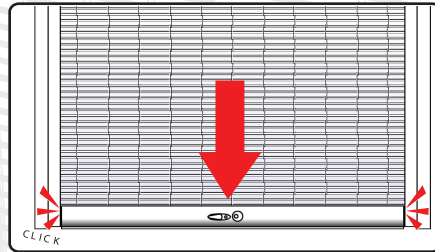

Lift Ready's exclusive Smart-Lock System allows end-users to engage the lock at a convenient height and then close the grille to the floor where the grille locks automatically.

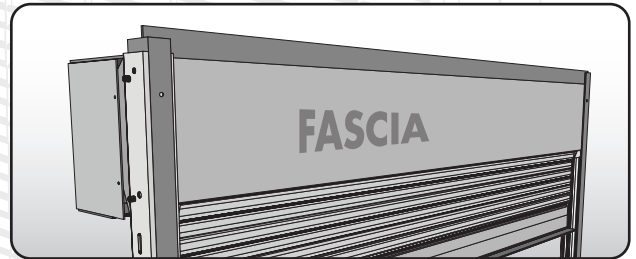

Optional hood to cover top, front and bottom of coil assembly. Optional fascia attaches to hood to cover back of coil assembly. Available in 26 Ga. steel, or 23 Ga. aluminum. (If Back of plate to Back of plate measurement is more than 10'0", a multiple piece hood is required.)

We offer larger sizes in the Rolling SB models.  
Please contact Customer Service at 800-663-4599 for details.

