

Product Data

Max Width	Unlimited	
Max Height	168"	[4267]
Panel Width	7"	[178]
Min. Pocket Width	8"	[203]
Weight Stacked	14.6lbs/ft ²	71kg/m ²
Weight Extended	1.15lbs/ft ²	5kg/m ²
Hinge Type	1 Piece Continuous	
Stack Ratio	6% of curtain width	
Stack Formula (Estimated)	6% of curtain width plus 3" [76] per post	

Color Options



Clear Anodized Standard (In Stock)



Black Anodized (In Stock)



Powder Coat

Curve Data



	Radius 10" [254]	Radius 14" [356]
90 Degree	—	•
120 Degree	•	—
135 Degree	•	—
150 Degree	•	—
Custom Curves	Available, please consult factory	

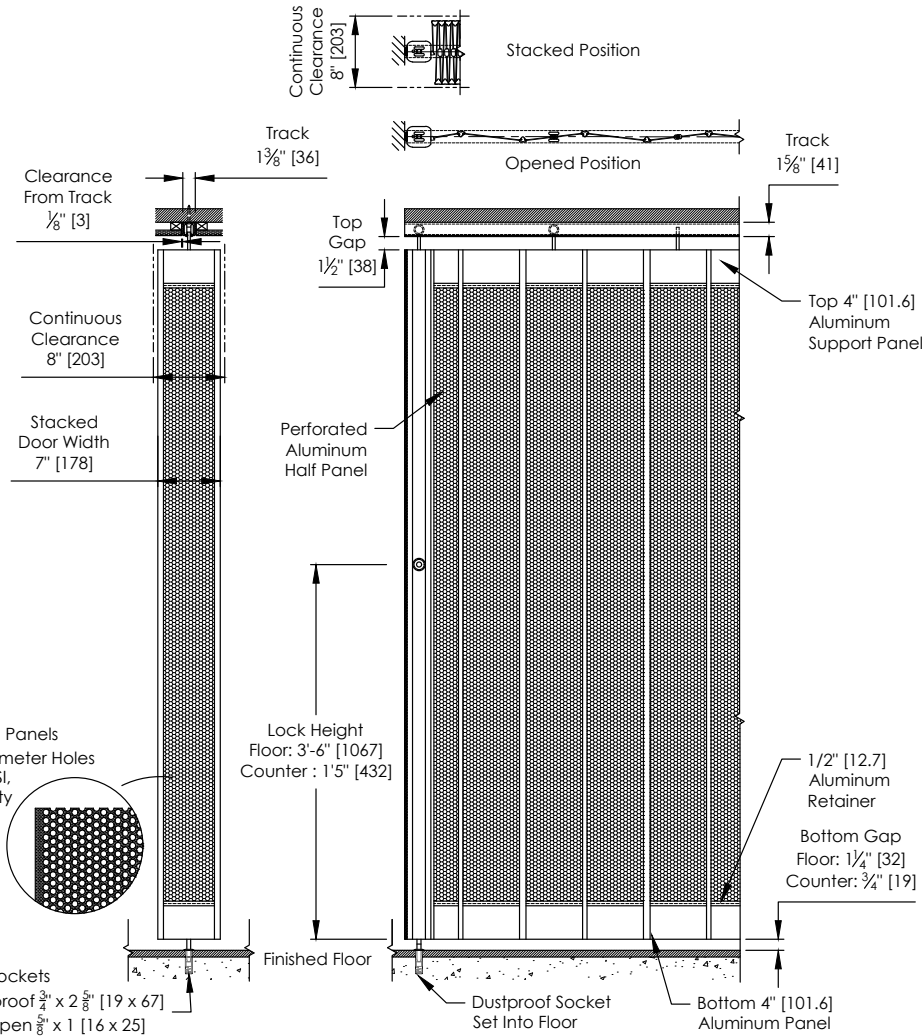

EL Right Angle Pocket (Typical)

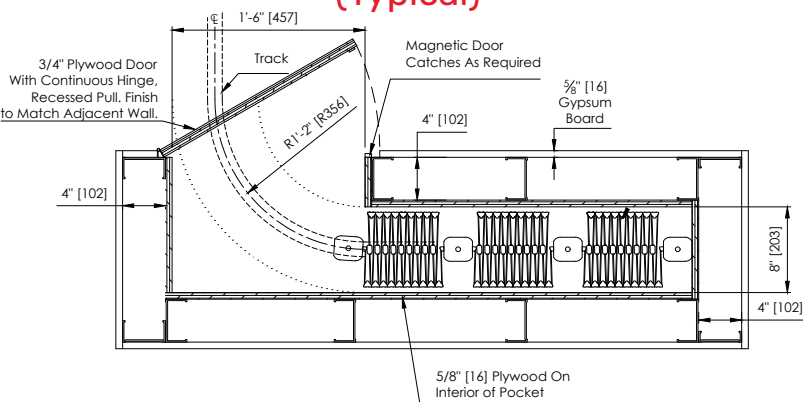

EL Straight Pocket (Typical)

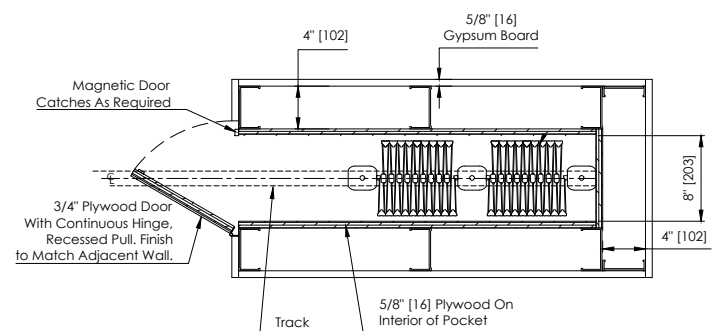

Post Data



	Post 1	Post 2	Post 3	Post 3	Post 5	Post 7	Post 9	Post 10
Dimension	Wall Channel	Hookbolt Lead	Bi-Part Channel	Bi-Part Hookbolt	Intermediate	Top and Bottom	Trailing	Fixed
Width to Door Length	0.75" [19]	2.75" [70]	1" [25]	2.75" [70]	2.75" [70]	3" [76]	1.5" [38]	0.75" [19]
Width to Stack Depth	0.75" [19]	2.75" [70]	1" [25]	2.75" [70]	2.75" [70]	3" [76]	1.5" [38]	0.75" [19]
Min Height	2" [51]	21.25" [540]	21.25" [540]	21.25" [540]	21.625" [549]	32.125" [816]	21.25" [540]	21.25" [540]
Max Height	168" [4267]	168" [4267]	168" [4267]	168" [4267]	168" [4267]	168" [4267]	168" [4267]	168" [4267]
Top Lock Rod Travel	-	-	-	-	-	-	-	-
Bottom Lock Rod Min Travel	-	-	-	0.5" [13]	0.5" [13]	0.5" [13]	-	-
Bottom Lock Rod Max Travel Floor	-	-	-	3.5" [89]	3.5" [89]	3.5" [89]	-	-
Bottom Lock Rod Max Travel Counter	-	-	-	2.5" [64]	2.5" [64]	2.5" [64]	-	-
Lock Height Floor Application	-	47" [1194]	47" [1194]	47" [1194]	47" [1194]	47" [1194]	-	-
Lock Height Counter Application	-	17" [432]	17" [432]	17" [432]	17" [432]	17" [432]	-	-
Features								
Adjustable Top Hanger	-	•	•	•	•	•	•	•
Universal LH and RH	•	•	•	•	•	•	•	•
Flush Mounted Lock Rod Operation	-	-	-	•	•	•	-	-
Pull Strap	-	Std over 108" [2743]	Std over 108" [2743]	-	-	Std over 108" [2743]	-	-
Plastic Flange 7" [178] (Max 120" [3048])	-	-	-	-	-	•	Std With EL	-
Plastic Flange 4.5" [114] (Max 120" [3048])	-	-	-	-	-	•	Std With SL	-

Egress Data

Clear Opening Width (Egress Door)	36" [914]
Clear Opening Height (Egress Door)	80.75" [2051]
Min Door Opening Height Required	89.375" [2270]
Hand of Operation	LH/RH
Total Length (includes Bi-Part Post)	36" [914]
Stack Required (includes Bi-Part Post)	6" [162]
Perforated Aluminum or Polycarbonate**	

Locking Options

Description	ADA Turnknob	LFIC	SFIC	StdMortise	Thumbturn
Front view					
Side view					

