

# SIDE FOLDING INSTALLATION GUIDE

**SLIM LINE** – 4 INCH  
**ELITE** – 7 INCH

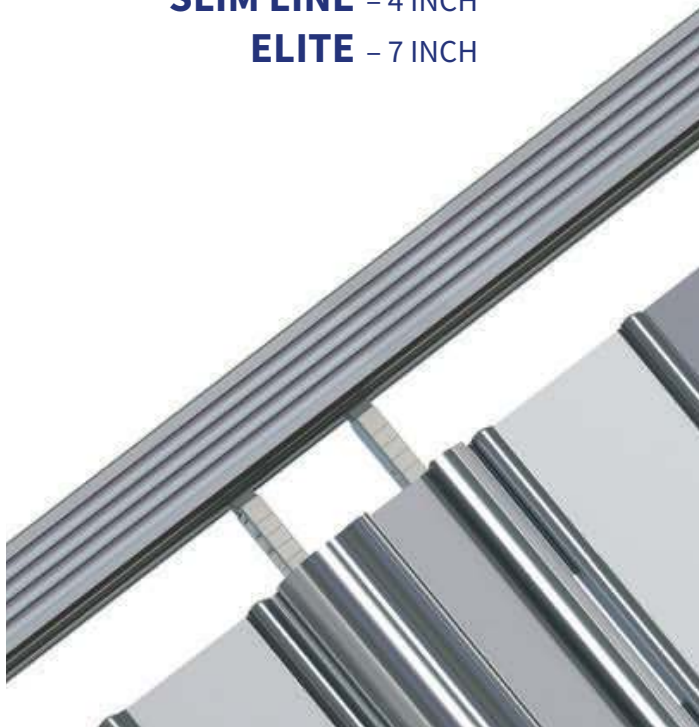

## TABLE OF CONTENTS

TOOLS REQUIRED .....	1
WARNINGS AND SAFETY INFORMATION .....	1
GENERAL NOTES .....	1
INSTALLATION STEPS	
STEP 1 SITE CHECK .....	2
STEP 2 TRACK .....	2
STEP 3 ORDER OF DOOR COMPONENTS .....	2
STEP 4 HANGING DOOR COMPONENTS .....	2-3
STEP 5 ATTACHING POSTS TO CURTAIN .....	3
STEP 6 POST INSTALLATION .....	4
POST DESCRIPTIONS .....	4
P01/02 – WALL CHANNEL HOOKBOLT .....	4
P03 – BIPART .....	4
P05 – INTERMEDIATE .....	4
P07 – TOP & BOTTOM .....	4
P09 – TRAILING .....	4-5
P10 – FIXED .....	5
PULL STRAPS .....	5
POST & CURTAIN ADJUSTMENTS .....	6-7
INSTALLATION CHECKLIST .....	7
PRODUCT WARRANTY .....	8
CLEANING AND CARE .....	8

## TOOLS REQUIRED

- Ladder or Work Platform
- Dolly (if required for heavy doors)
- Mitre Saw with Non-Ferrous Blade
- Cordless Drill & Hammer Drill
- Concrete Drill Bits (1/4", 3/16", 3/4")
- Standard Drill Bits (1/8", 3/16", 1/2")
- Driver Bits (#2 Square x 3" long, #2 Phillips (star), 5/16" Hex)
- Screwdrivers (1/4" Flat, 1/8" Flat, #2 Square, #2 Phillips (star))
- (2) 7/16" Combination Wrenches or Drivers and Sockets
- 8 oz. Hammer
- Rubber Mallet
- Metal File
- 4" Squeeze Clamps
- Pencil
- Measuring Tape
- Chalk Line
- Level (4')
- Gloves
- Utility Knife
- Mild All-Purpose Cleaner
- Cleaning Cloths

## WARNINGS AND SAFETY INFORMATION

**Carefully read and understand the following safety information before installing or repairing these products.**

**If you do not understand these instructions or have any questions about the product or its installation, contact customer service at (800) 663-4599.**

### Intended Use

The products provided are intended for daily use by trained individuals.

High cycle use, improper handling, or abuse of the product may cause premature failure of components, leading to possible serious injury to persons, or damage to property.

Use supplied bi-part posts to separate doors into manageable sections for transport.

Some of these products contain curved track. Special attention is required to guide doors through the curved track sections to avoid excess wear and damage to components and adjoining surfaces.

The product contains metal edges and corners that may be sharp. During operation, only handle the doors by way of the operating posts or smooth panel or hinge surfaces to avoid injury.

The product may contain egress door sections and other egress-related hardware. Ensure that all of these components are functioning according to applicable codes and regulations. Any persons operating the product must be trained in the setting and handling of these components to ensure proper function in case of an emergency.

### Structure

Before installing the door, verify that all mounting surfaces are capable of safely supporting the attached loads.

Ensure that all connections to the structure are secure and that suitable fastening materials are used.

### General Safety Instructions

The installation and repair of these products should only be carried out by specialists or competent individuals. General knowledge in proper construction techniques, safe tool use, and job site safety are required.

Installation of these products may require overhead work and/or the use of ladders or elevated work surfaces. Use head protection where appropriate and follow all safe use guidelines for any equipment used.

Some of the products supplied may be heavy. Use lifting devices where appropriate and follow safe lifting practices.

It is the installer's responsibility to follow all local, state, and national regulations and codes, which supersede any information previously received.

We strive to provide all materials and components accurately as ordered by the customer, however it is the installer's responsibility to ensure that all components installed function in a safe and approved manner.

## GENERAL NOTES

Proper installation and adjustment of door components is vital in ensuring that the product operates correctly and without problems for years to come.

Double-check all connections and component operation.

Pay particular attention to:

- Fasteners – Verify that all door components are securely fastened and that any fastening to the building structures is done with the appropriate fastener type and quantity.
- Track joints – Verify they are tight, de-burred, and both pins and alignment bars span the joint.
- Wheels – Verify all wheels are facing the correct way and travel smoothly over the length of track.
- Locking points – Verify proper lock function at all locking points.
- Clearances – Verify that the door has a free path of travel over the entire length of track, including the storage pocket area.

Finally, ensure that the personnel who will be operating the door have received proper training in its use and operation. Many field issues that arise are caused by improper use by unqualified operators.

## SITE CHECK

STEP 1

### MEASURE OPENING

Verify that site conditions match the layout drawing provided with the door.

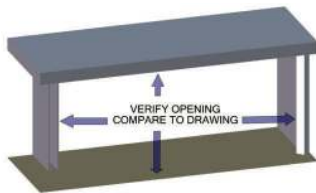
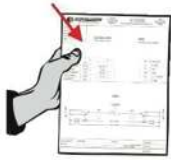

### CHECK HEADER

Verify that header support is continuous and can support the entire weight of the door over the entire length, including in the pocket area.

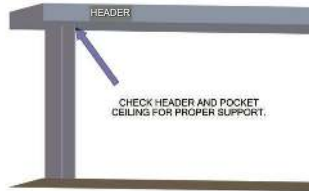

### CHECK FLOOR

Floor should be level. Ensure pocket area is free of protrusions.

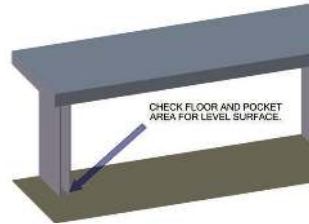

## TRACK

STEP 2

### CLEARANCES

Maintain the clearance listed below over entire length of track, including in pocket areas. Larger clearances are advisable around curves, if possible.

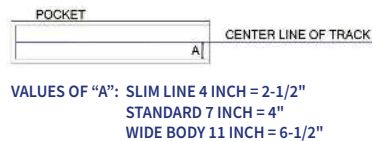

### PREPARATION

**IMPORTANT:** Ensure all cut edges on track are filed smooth. Failure to do so may cause the door to catch or bind at joints.



Track is pre-drilled for #10 x 2" screws (provided).

If other fasteners are being used, mounting hole sizes in track may need to be changed.



### TRACK LINE

Using a chalkline, mark the path of the track across entire opening and into pocket area. This will be the centerline of the track.

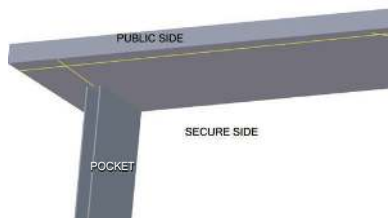

### ORDER OF TRACK INSTALLATION

**Curves** should be installed first to ensure proper layout.

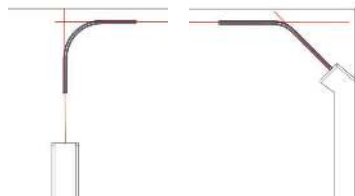

**Straight** track is then installed.

**Note:** Leave one piece of track uninstalled. The gap is required to load the door into the track.



## JOINING SECTIONS OF TRACK

**Note:** It is important that every joint in the track has an alignment bar and two pins as illustrated.

Once installed, the bar and pins should bridge across the gap to securely align the two track pieces. Use a hammer and small flat screwdriver if needed.



**Line up** the track with the header and chalkline

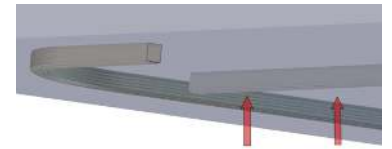

**Join** the pieces of track

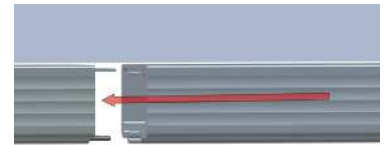

**Joint** must be tight with no gaps to ensure the trolleys do not catch and the door travels smoothly through the joint.



Screw securely to header using all pre-drilled holes.

## ORDER OF DOOR COMPONENTS

STEP 3

### REFER TO DRAWING

The layout drawing in your installation package will show you the order of the door sections and posts.

Each section of door and locking post is numbered.

**IMPORTANT:** Hang posts and sections in the same order as they appear on the drawing, making sure that the SECURE SIDE of each is facing the correct direction.

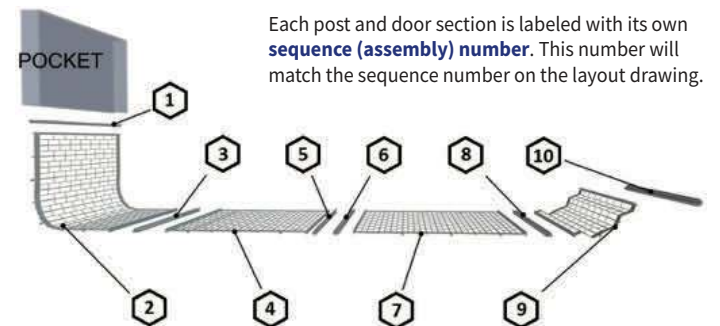
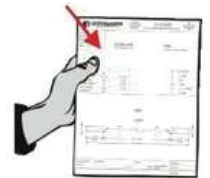

Each post and door section is labeled with its own **sequence (assembly) number**. This number will match the sequence number on the layout drawing.

## HANGING DOOR COMPONENTS

STEP 4

### HANG FIRST POST

**Check** the drawing for the post that is furthest away from the break in the track. This will be the first component to hang (see Step 6 for post descriptions).

**Lift** the post up and slide the trolley into the track.

**Note:** The trolley assembly could point either direction depending on door layout.

**IMPORTANT:** Check the drawing to verify that the locks on the post are facing the correct way. If the locks are backwards, turn post around in the track before proceeding.

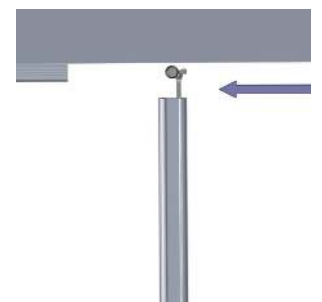

## HANG FIRST SECTION OF CURTAIN

**Check** the drawing for the section of curtain to hang next to the post.

**IMPORTANT:** Verify that the correct side of the curtain is being hung toward the secure side of the track. The screw channel on the connectors at each end of the door section will always point toward the secure side.

**Slide** the transfer track provided onto the trolleys. **ENSURE NO TROLLEYS ARE SIDEWAYS** in the track.



**Lift** the curtain and place the transfer track end-to-end with the installed track.

**Hint:** Using a properly-sized block of wood under the door will help hold up the weight of the section when it is vertical.

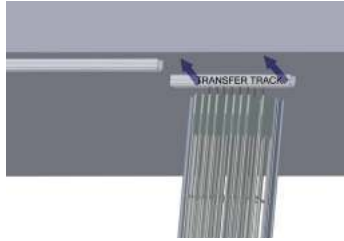

**Slide** the curtain section into the installed track.

**CAUTION: The transfer track will fall after the curtain is transferred into the installed track unless restrained.**

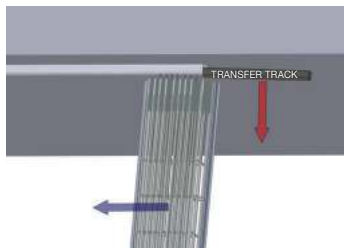

**Repeat steps until entire door is hanging.**

**VERIFY THAT ALL POSTS AND SECTIONS ARE IN THE CORRECT ORDER AND ORIENTATION.** Once verified, complete final track installation.

## ATTACHING POSTS TO CURTAIN

STEP  
5

**Place** the curtain section close to the post.



**Insert** the hood end of the connector into the slot on the post and rotate the curtain connector flat against the post.



**Flush** the connector with either the top or bottom of the post.



**Attach** by inserting the #6 self drilling screw in the screw channel. Place screws 2" from each end and spaced every 18".



## POST INSTALLATION

STEP  
6

### SYMBOLS, NUMBERING AND NAMING

Post Name	Wall Channel	Hookbolt	Bipart	Intermediate	Top & Bottom	Trailing	
Post Number	1	2	3	5	7	9	10
Approval Drawing Symbol							
Elevation View							

### POST DESCRIPTIONS

#### P01 – Wall Channel

A floor-to-track extruded aluminum channel that the hookbolt fits and locks into. This channel is secured permanently to the wall.

#### P02 – HookBolt Lead

One of the options for the leading edge of the door. This Post has a hookbolt lock that secures it to the Wall Channel. Optional Double Hookbolt or Top Locking available.

#### P03 – Bipart

A pair of posts that lock together with a hookbolt, with an added lock rod to keep curtain in place. It is used to separate larger doors into manageable sections, or to split the door to stack in two different directions. Doors should have at least one Bipart Post for every 30' [9144 mm] of width. Optional Top Locking available.

#### P05 – Intermediate Post

A middle post in a door located between door sections, containing a spring-loaded lock rod that engages a floor or counter socket to keep the door in place. As well as being located at intervals (no more than 10' [3048 mm]) along straight sections of door, Intermediate Posts should be placed on or near the center of curves.

#### P07 – Top and Bottom Locking Post

One of the options for the ends of a door. Spring-loaded lock rods engage a Floor or Counter Socket and the track support, and are unlocked with a keyed cylinder or thumbturn. Optional leading edge treatments include rubber bumper, flange, or blank face.

#### P09 – Traveling End Post

The Trailing Post terminates a door inside of storage area. It is free to travel back and forth inside of the pocket. The post self-locks into the permanent header and floor stops, preventing the door end from leaving the pocket. A rear flange helps fill the opening to the side of the post to prevent reach through.

#### P10 – Fixed End Post

Fixes the end of a door permanently to a wall or structure.



## P01/P02 – WALL CHANNEL/HOOKBOLT

**Measure** the distance from the floor to the underside of track. If required, trim the base of the wall channel to match.

**Center** the wall channel directly under the track.

**Check** that the wall channel is plumb.

**Mount** the wall channel using the screws provided in the pre-drilled holes.

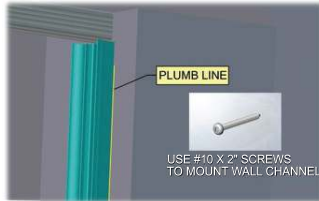

**Set** the lead post into the wall channel and operate the key to make sure the hook bolt engages the lock plate.

If required, adjust the lock plate in the wall channel to ensure a good connection. Refer to post adjustments section.



## P03 – BIPART

**Note:** Install the Bipart post only after the posts at the ends of the door have been installed.

**Lock** all door sections together and lock two end posts in place. Fully extend door and position bipart in desired location.

**Mark** location on floor directly under lock rod in female post.

**Unlock** the Bipart and move male post away in order to lower the lock rod to double-check marked location.

**Drill** the hole to accept the floor socket.

Drill size:

- 3/4" diameter x 2-3/4" min. deep for dustproof floor socket
- 5/8" diameter x 1" min. deep for counter trim ring

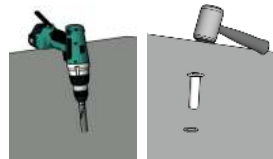
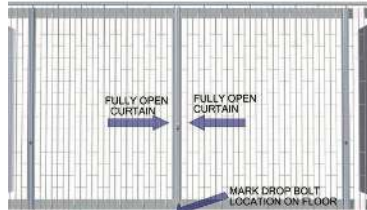

**Insert** the socket into the hole. Use a rubber mallet to help if needed. Take care to not strike the socket at an angle or with too much force, as damage may occur.

## P05 – INTERMEDIATE

**Lock** all previously-installed posts in place.

**Extend** the door fully and allow the intermediate post to hang naturally.

**Lower** the drop rod and mark the location on the floor.

**Note:** If the door has a Bipart post, begin with the Intermediates adjacent to the central Bipart posts and work your way outwards. This will ensure that any slack in the door is located at the ends of the door, providing the best looking results. If a Trailing post is used, all slack should go towards that end.

**Drill** the hole to accept the floor socket.

Drill size:

- 3/4" diameter x 2-3/4" min. deep for dustproof floor socket
- 5/8" diameter x 1" min. deep for counter trim ring

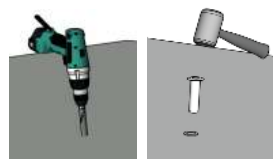
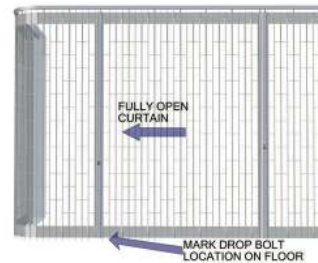

**Insert** the socket into the hole. Use a rubber mallet to help if needed. Take care to not strike the socket at an angle or with too much force, as damage may occur.

## P07 – TOP & BOTTOM

**Place** the Top & Bottom post in the locking position (usually resting against the end wall or pocket door). Verify that the post is hanging plumb.

**Mark** the lock rod locations on the track and floor.

**Drill** 1/2" diameter hole in the track and track support for the top lock rod.

**Drill** the hole to accept the floor socket.

Drill size:

- 3/4" diameter x 2-3/4" min. deep for dustproof floor socket
- 5/8" diameter x 1" min. deep for counter trim ring

**Insert** the socket into the hole. Use a rubber mallet to help if needed. Take care to not strike the socket at an angle or with too much force, as damage may occur.

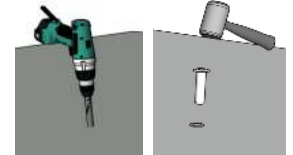
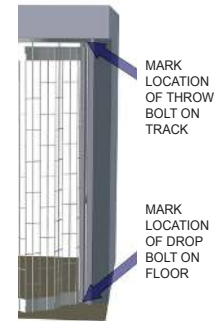

## P09 – TRAILING

**Lock** other posts in place. The trailing post should be the last post installed.

**Extend** curtain as far into the pocket as it will go without being tight.

A door that is too tight is difficult to lock, while one that is too loose is unattractive.

**Place** the V-stop flush with the front connector face of the trailing post.

**Mark** the front mounting hole on the floor.

**Remove** the door and V-stop from the pocket area.

**Bend** the V-stop as required to fit the shape of the pocket

SECURE SIDE

SECURE SIDE

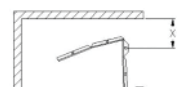
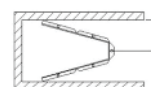

VALUES OF X

SLIM LINE 4 INCH = 2 1/2"

STANDARD 7 INCH = 4"

WIDE BODY 11 INCH = 6 1/2"

**Drill** a 1/4" hole, 1 1/4" deep where marked in the pocket. Replace V-stop and fasten using nail-in anchor provided.

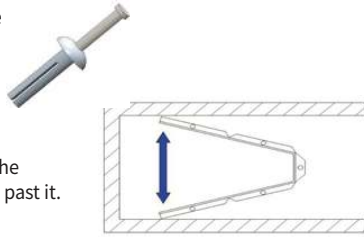

**Expand** the V-stop stop to ensure the trailing post won't be able to move past it.

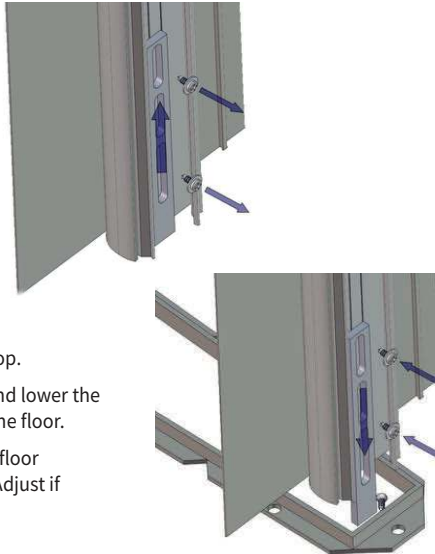

**Detach** trailing post from curtain (reverse directions in Step 5), and raise the bottom stop enough to pass over the V-stop.

**Move** trailing post behind V-stop.

**Loosen** the retaining screws and lower the bottom stop until it is just off the floor.

**Check** that the stop clears the floor though the entire pocket are. Adjust if necessary.

**Move** trailing post until the bottom stop is up against the V-stop.

**Check** that the post is hanging plumb.

**Install** ceiling stop with #10 x 2" screws just in front of the post top stop.

**Loosen** the hex bolts to adjust the height of the top stop.

**Raise** the top stop so that it catches to ceiling stop. Leave as little clearance as possible between the top stop and the ceiling.

**Re-attach** trailing post to curtain (see Step 5).

## P10 - FIXED

**Center** the fixed post 1.5" under the track.

**Check** that post is plumb.

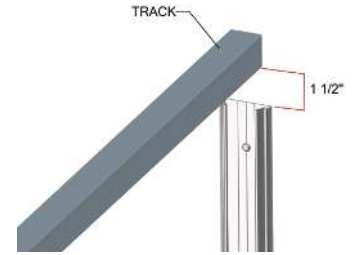

**Screw** to wall using 2" screws provided.

If material other than metal or wood is being fastened to, the installer must provide appropriate fasteners.

**Attach** the adjacent curtain (See Step 5).

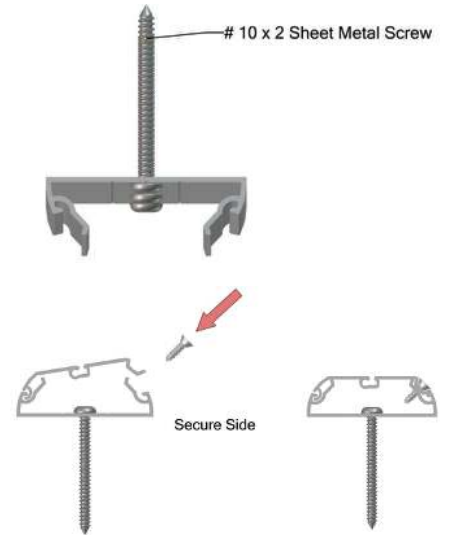

## PULL STRAPS

Pull straps are supplied with leading end posts on all counter-height doors and taller full-height doors.

The pull strap allows the operator to move the door sections smoothly, as they pull the door from a higher point than can be grasped by hand.

**Unravel** the pull strap and unlatch the buckle. Position the bottom of the pull strap at a comfortable height for the operator. This is typically 1" above lock components on full-height posts. Doors on tall counters may require the strap to hang below the lock components to be easily accessible. Consult with customer for best position if in doubt.

Ensure the hook and loop fastener above the handle is located in an area where it can be adhered to the post.

**Trim** excess strap below the top of the buckle and cinch closed.

**Remove** the backing from the hook and loop located above the handle. Pull strap so that it is hanging straight and press firmly to adhere to post.

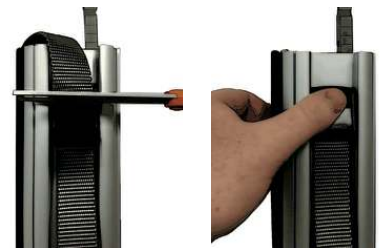

## HEIGHT ADJUSTMENT OF LOCK PLATE – LEAD POST & FEMALE BIPART

**Remove** the two retaining screws in the lock plate and adjust the plate up or down.

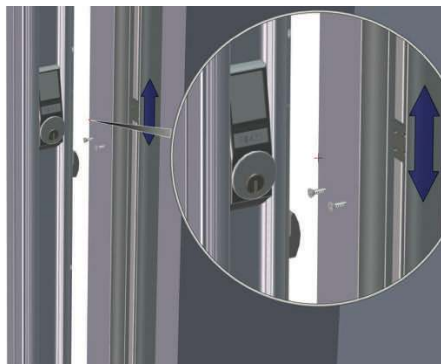

**Re-fasten** the plate to the post. Use alternate mounting holes if required. Test for proper function with hookbolt.

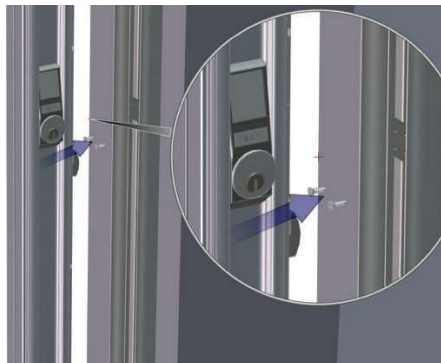

## CYLINDER REMOVAL - LEAD POST

**Remove** the 3 retaining screws and the cover plate.

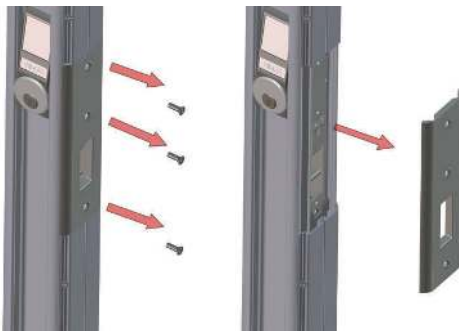

**Loosen** the set screw.

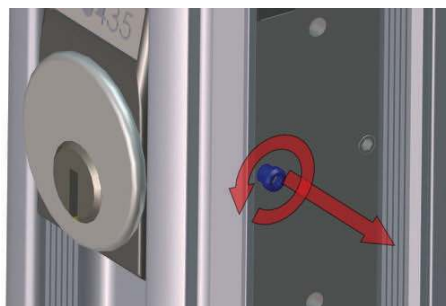

**Remove** the cylinder by unscrewing it counter-clockwise.

Hint: A partially-inserted key makes turning the cylinder easier.



## HEIGHT ADJUSTMENT – ALL POSTS

**Remove** the two screws holding the hanger in place.



**Adjust** the height of the hanger. Use the indexing marks on the side of the post hanger as a guide (1/4" intervals).

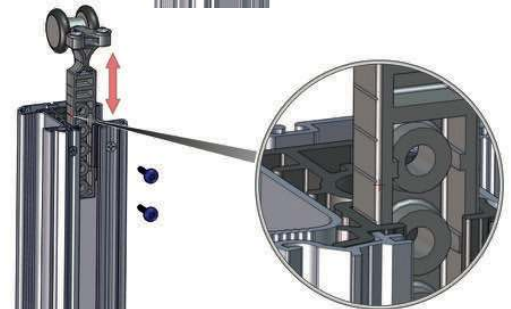

Indexing Marks  
1/4" intervals

**Replace** the hanger screws. Select appropriate holes to ensure that both screws have purchase in the support block

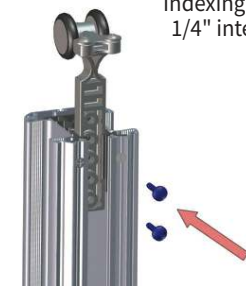

## LOCK ROD THROW ADJUSTMENT – FEMALE BIPART

**Remove** the retaining screw and the lock cover plate.

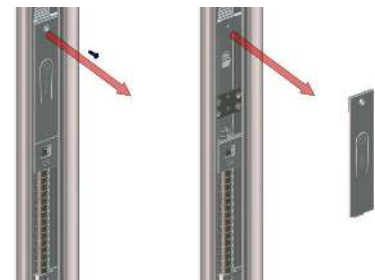

**Remove** the two screws in the lock plate.

**Adjust** the plate up to shorten throw, or down to lengthen throw.

**Replace** the lock plate retaining screws.

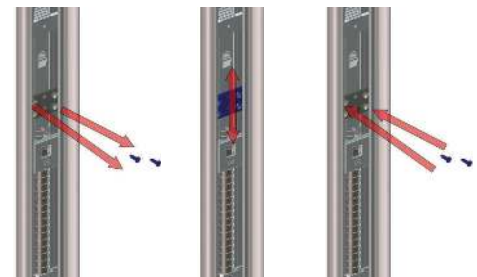

**Replace** the cover plate and retaining screw.

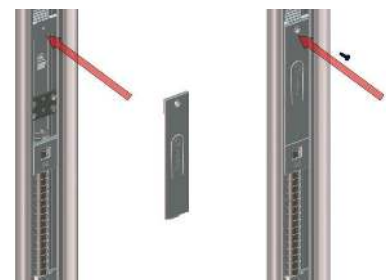

## CYLINDER REMOVAL – INTERMEDIATE AND TOP & BOTTOM

**Unlock** the post so that the lock plate(s) retract.

**Adjust** the lock plates up/down (if required) so that the set screws in the lockset are accessible through the oval cutouts (see instructions on next page.).

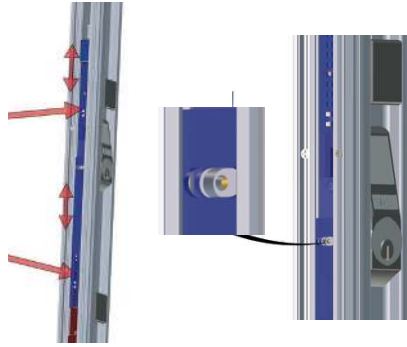

**Remove** the two screws in the lock plate.

**Adjust** the plate up to shorten throw, or down to lengthen throw.

**Replace** the lock plate retaining screws.

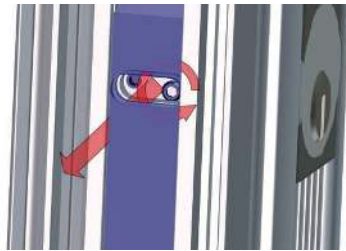

**Replace** the cover plate and retaining screw.



## LOCK ROD THROW ADJUSTMENT – INTERMEDIATE AND TOP & BOTTOM

**Remove** the side of the post closest to the hanger stem.

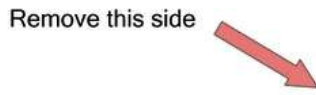

**The top lock rod** will always travel 1.5" from unlocked to locked, but the position is variable.

**The bottom lock rod** will always retract to the same unlocked position, but the length of throw is variable.

To adjust the stickout of the top rod, or to adjust the length of throw on the bottom lock rod.

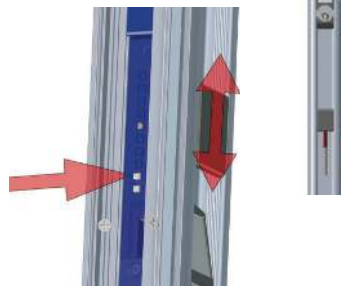

**Depress** the spring-loaded pins in the lock plate

**Slide** the plate up or down in 1/4" intervals until the pins engage the lock plate at the required height.

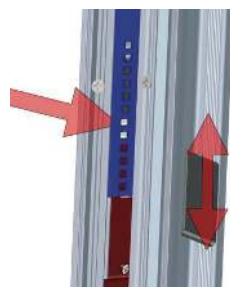

## CURTAIN HEIGHT ADJUSTMENT (if applicable)

### METHOD 1

- Adjustment of 1" upward or downward maximum.  
**IMPORTANT:** All trolleys must be adjusted to the same height.
- Slightly loosen set screw in panels and posts with 5/64" hex key (provided in hardware bag).
- Insert hex key into hole in shafts
- Turn clockwise to raise curtain
- Turn counterclockwise to lower curtain
- Re-tighten set screw—**IMPORTANT**

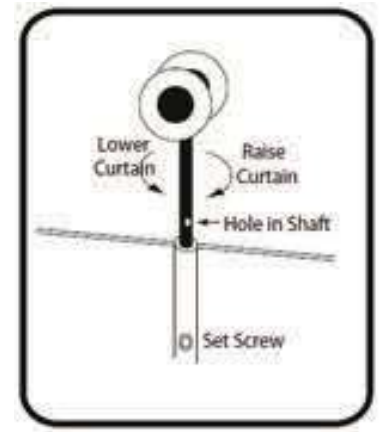

### METHOD 2

- Remove door from track
- Remove set screw with 1/8" hex key (not provided)



- Raise or lower hanger rod in 1/2" increments (max 1")
- Align cutout in rod with hole in panel
- Replace set screw

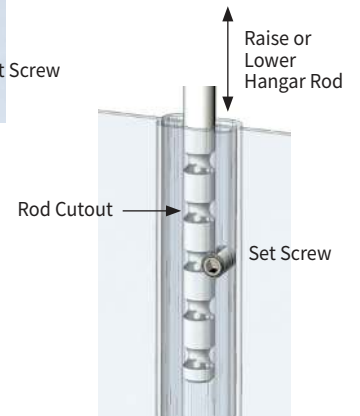

## INSTALLATION CHECKLIST

✓ TRACK	
	All joints are square and tight
	Alignment bars and pins bridge all joints
	Open ends are blocked
COMPONENTS & CONNECTIONS	
	All locks are facing the proper direction
	All curtain connectors fastened on secure side of door
	Connectors all securely fastened
FIT & FUNCTION	
	All posts and locks operate properly
	Door moves smoothly over whole track
	Door fits properly in storage area(s)
HANDOVER TO CUSTOMER	
	Door is clean and in good condition
	Keys and documentation have been delivered
	Customer has reviewed and been trained to operate door



## MAINTENANCE

**Important!** All equipment must be maintained by a trained service technician. Serious personal injury can result if an inexperienced person attempts to service any product. Contact our Customer Service department at (800) 663-4599 to locate the nearest authorized service company.

## CLEANING AND CARE

Clean with mild soap or detergent (e.g. Joy® Dishwashing Liquid) and lukewarm water. Rinse well with clean water. Dry thoroughly with a chamois or moist cellulose sponge to prevent water spots.

For tough cleaning jobs, Fantastik® all purpose cleaner or other household spray cleaners may be used. Important: spray solution on a clean cloth and rub.

**DO NOT** spray directly on closure. Rinse well with clean water and dry thoroughly with a chamois or moist cellulose sponge if recommended by cleaner manufacturer.

**DO NOT** use abrasives of any kind.

Never scrape the surface with sharp instruments.

We continue to strive to adopt the principles of sustainable development. We are committed to protecting the environment, to pollution prevention and to maintaining public health and safety during all phases of our operations. In order to achieve this goal, we maintain a proactive, continuously improving, environmental management system which systematically reviews any environmental aspects over which we have control. In this spirit, we have assessed the cleaners that we recommend to our clients, in order to ensure that they are both effective on our products and as benign as possible to the environment.

In all cases, it is preferable to prepare only as much cleaning solution as will be required for the job at hand. Any residual solution should be disposed of according to local, State, Provincial, and Federal laws.