

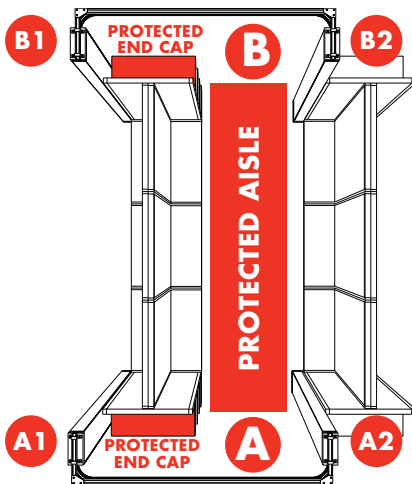

# DYNAMIC<sup>®</sup>

www.DynamicClosures.com

## LAYOUT

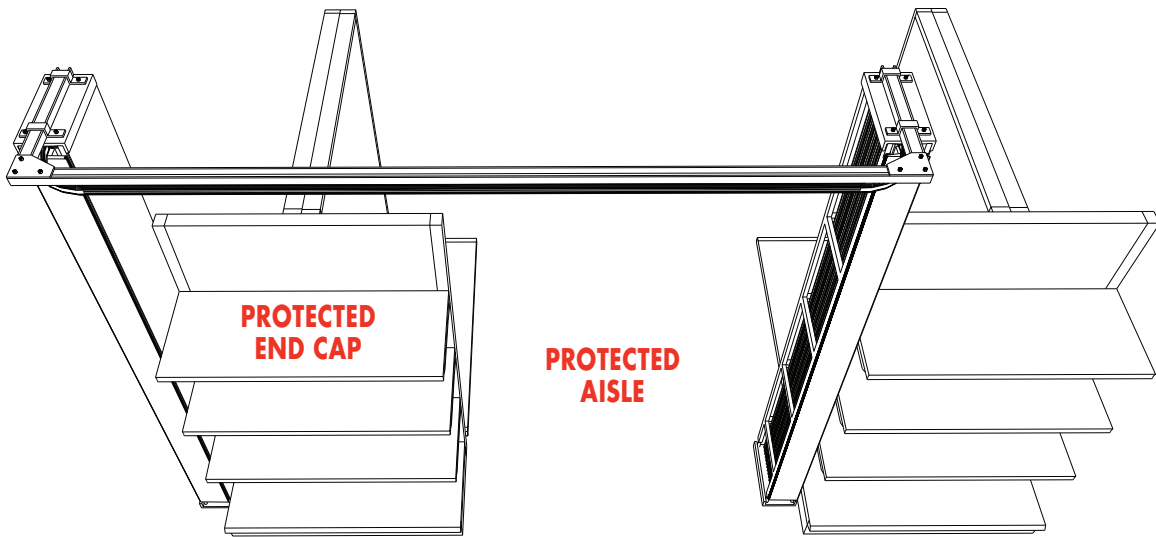

Above is a front view of the finished installation.

The instructions illustrate side A. Repeat for side B.

At left is a top view of the finished installation.

## 1

## START

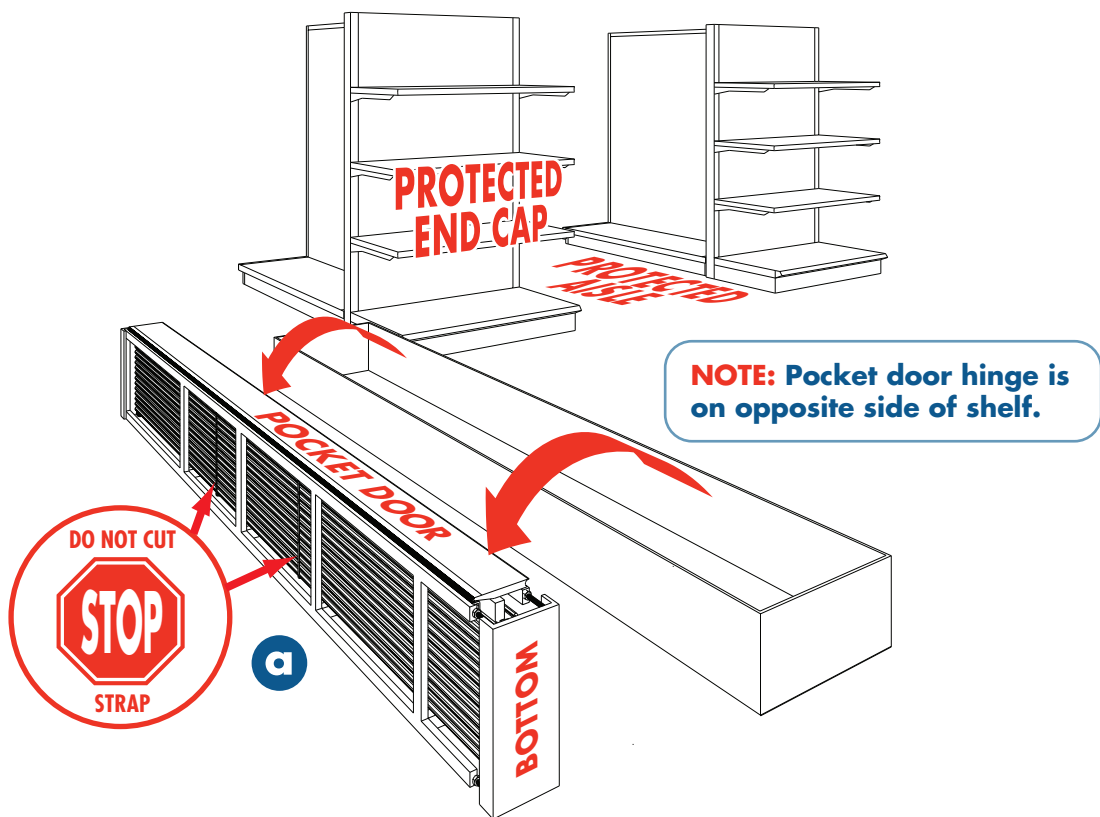

**a** Lift and stand with back of pocket on floor and pocket door facing up.

**b** Laminate side of pocket will be against the shelving unit.

2

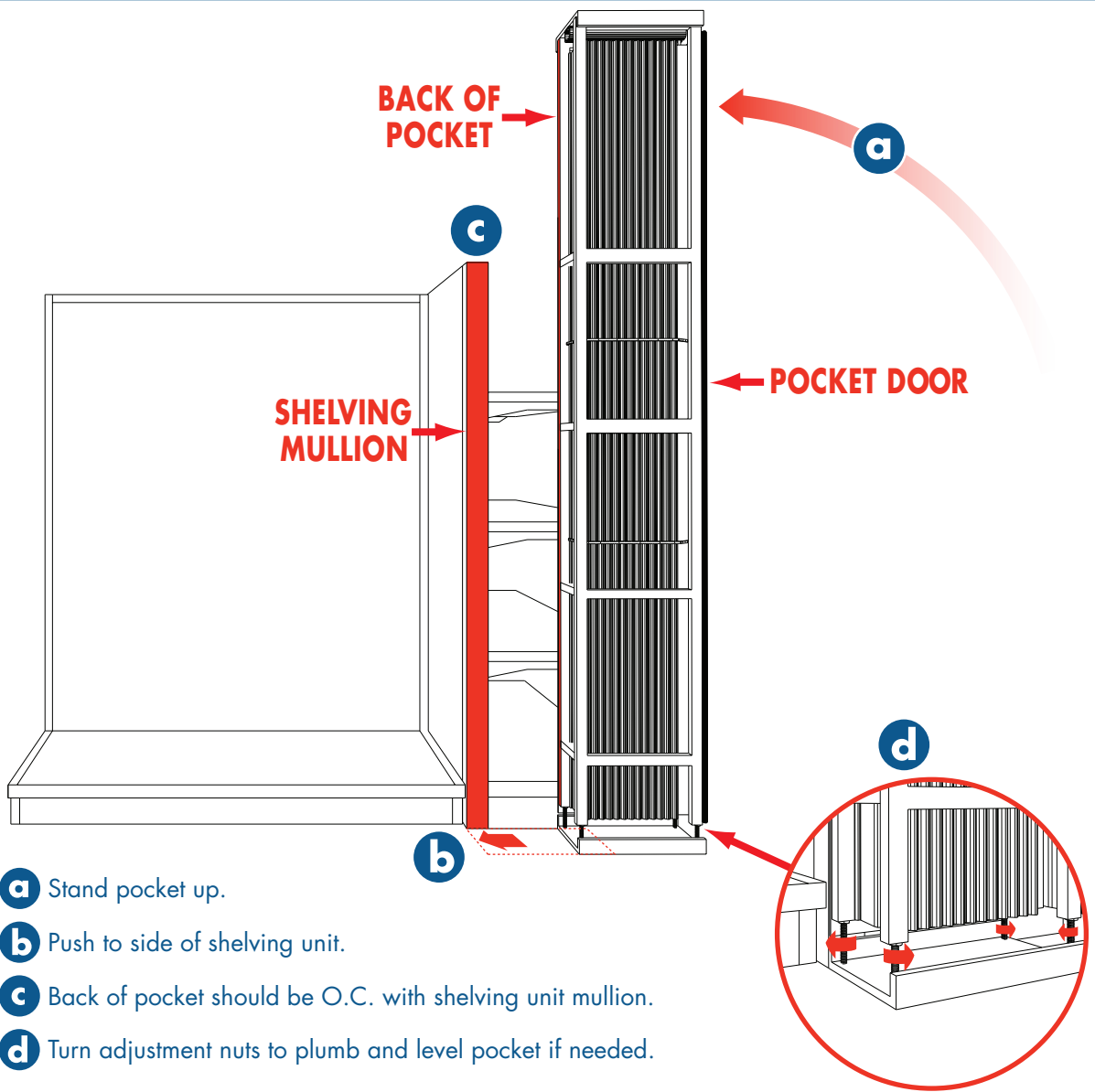

3

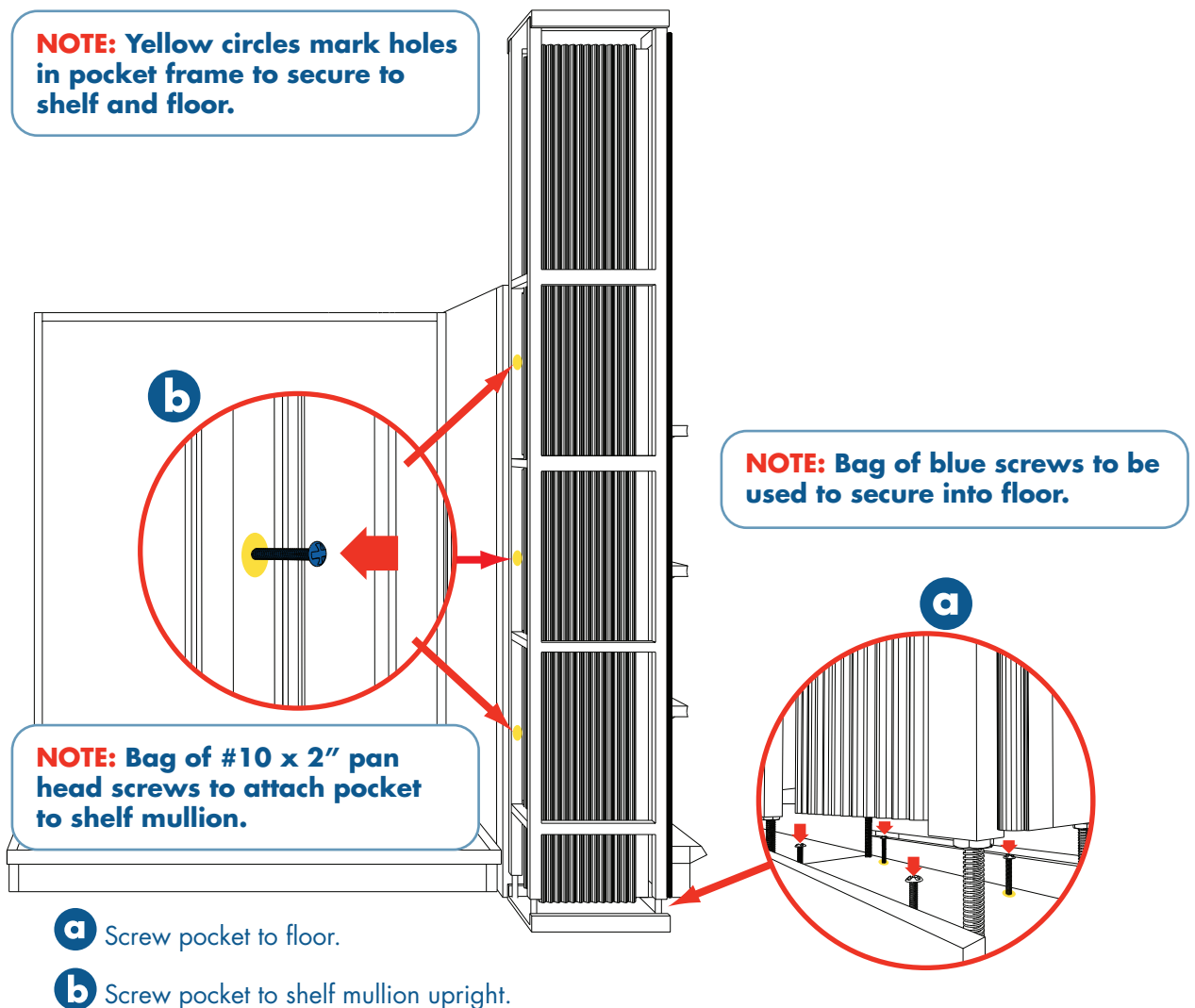

4

Repeat Steps 1-3 for second pocket.  
Pockets should be exactly 11 ft. 5 in. apart.

5

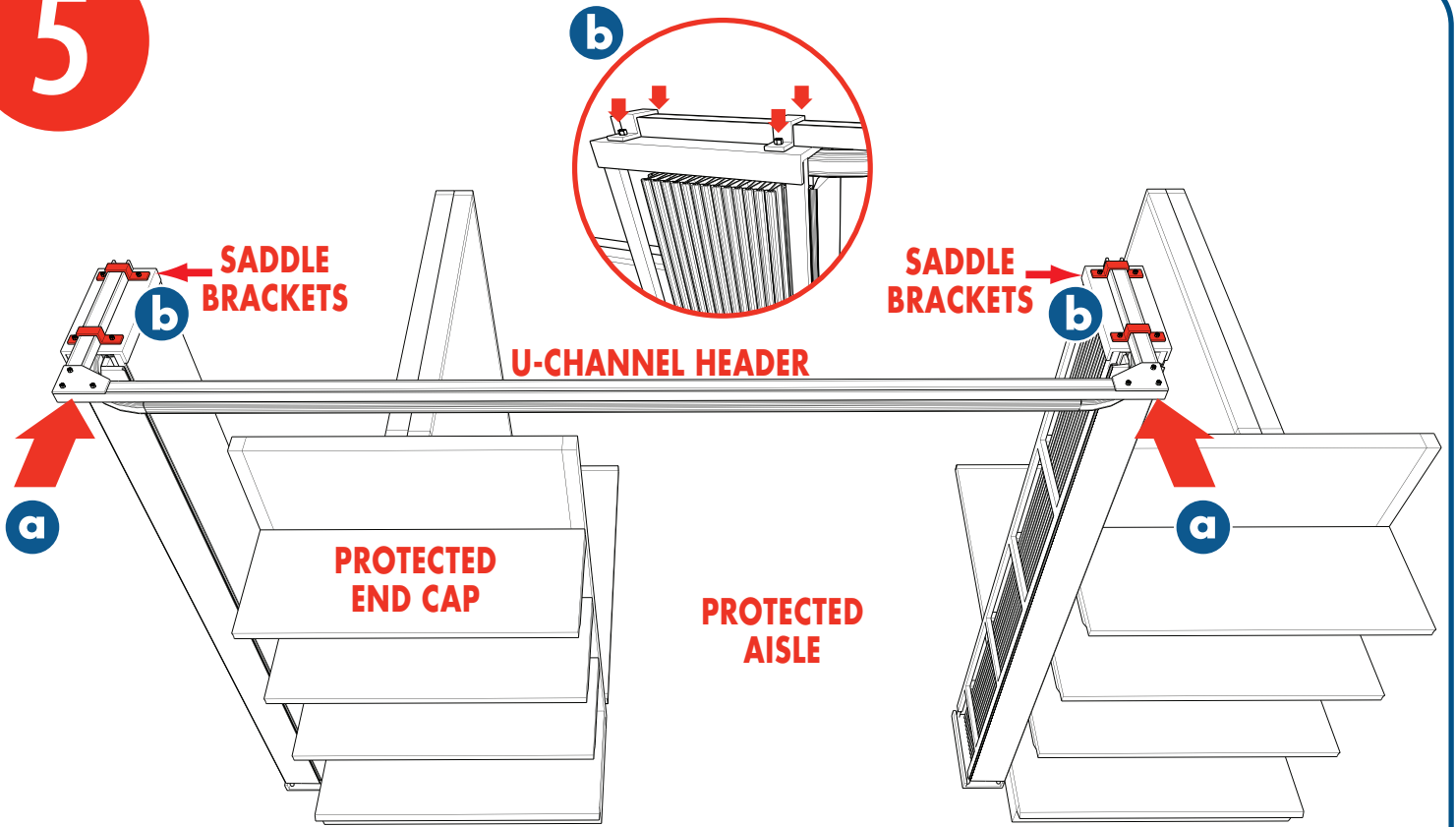

- a** Slide U-channel header into saddle brackets on top of pocket.
- b** Tighten header bracket nuts (x4).
- c** Tap track pins from header track into pocket track.

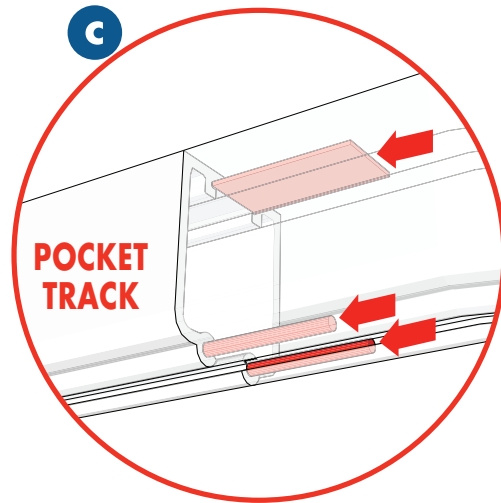

6

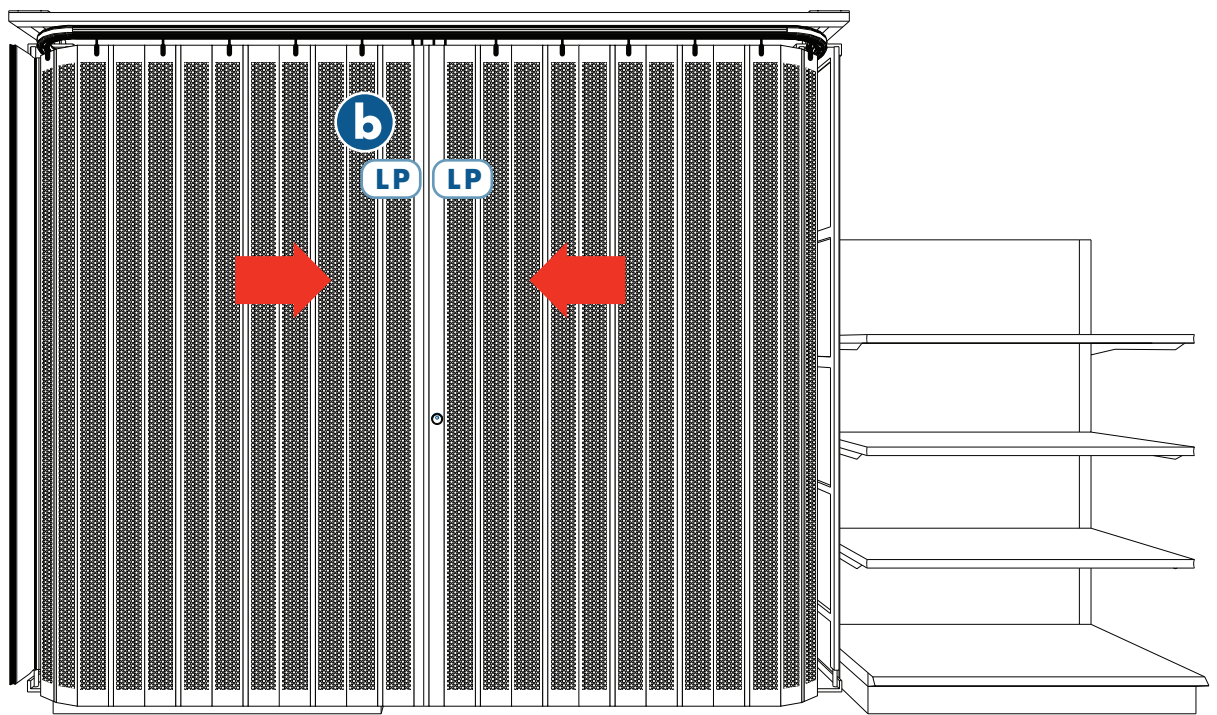

- a** Cut Straps.
- b** Pull closure across to middle, locking lead posts (LP) together.
- c** Mark location of lead post drop bolt.
- d** Using a 3/4 in. drill bit, install socket into floor.

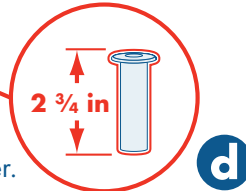

7

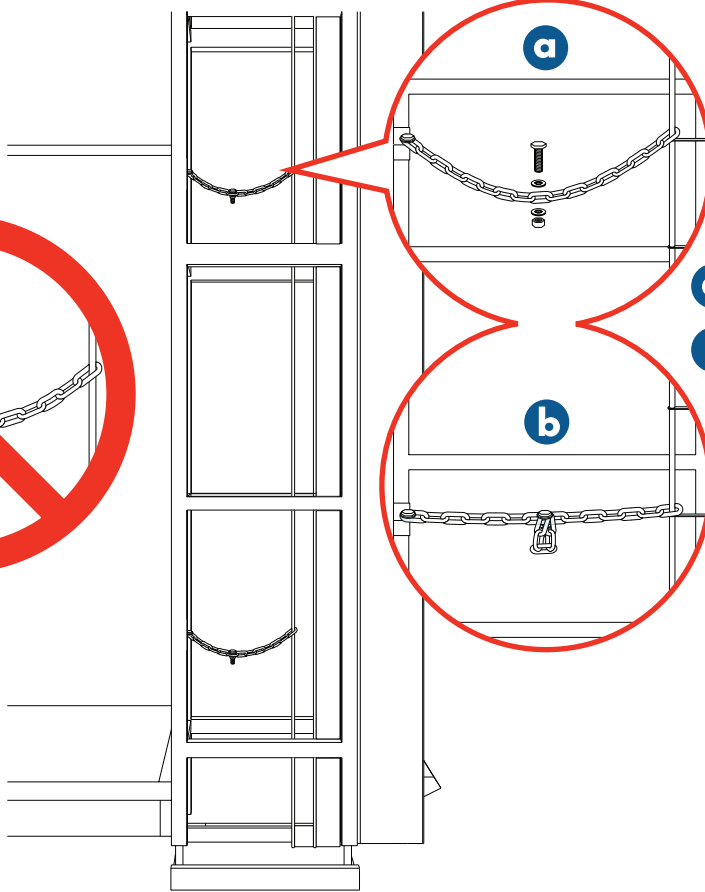

**a** Gather chain to remove slack.

**b** Insert bolt through two links and tighten.

**NOTE:** Closure should have minimum slack, yet can be locked easily.

8

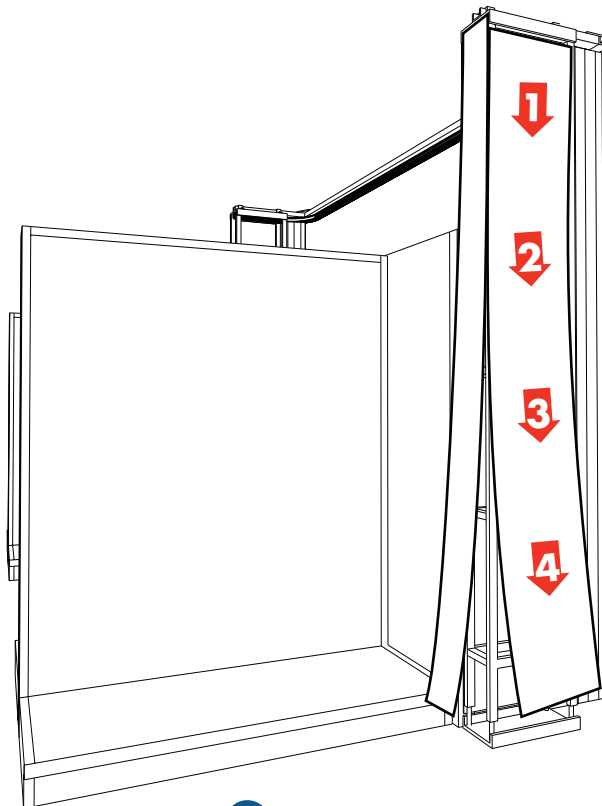

**a** Remove paper from double sided tape.

**b** Apply laminate to side and back from top to bottom checking that laminate stays square.